



The Heart of Industry

IWAKI

IWAKI
MAGNETIC
DRIVE
PUMPS

MDM

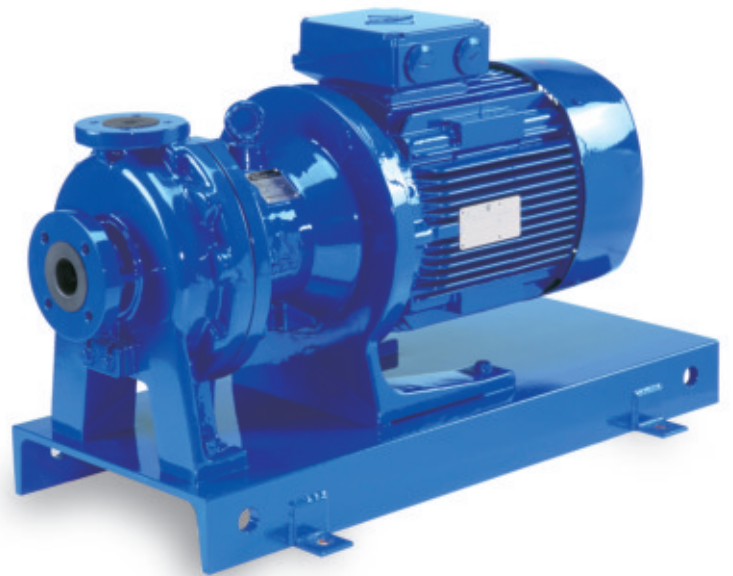

Patent

JAPAN / U.S.A. / TAIWAN / EU / CHINA

Solutions for chemical handling applications

Magnetic drive process pump resistant to dry run damage

The MDM Series of Magnetic drive process pumps have wetted parts made of fluoro-resin. Natural PFA and CFRETFE being standard materials of construction. The MDM features a unique mechanism which gives a greatly improved performance against dry running (Non contact system). Applications cover a wide range of chemical process duties from acid to alkali together with high purity chemicals for the semiconductor industry.

Unique design prevents dry running

(Non contact system) (PAT.)

The pump design features a mechanism to withstand dry running. High magnet power of the rare earth magnets prevents the magnet capsule coming into contact with the thrust ring of the rear casing, thus preventing melting of fluoro-resin components due to heat generation. This greatly improves resistance against dry running in comparison with conventional magnetic drive pumps made of fluoro-resin.

Note: Only CF type (fitted with high density carbon bearing) can cope with dry running. Dry running is not permitted in the case of KK type.

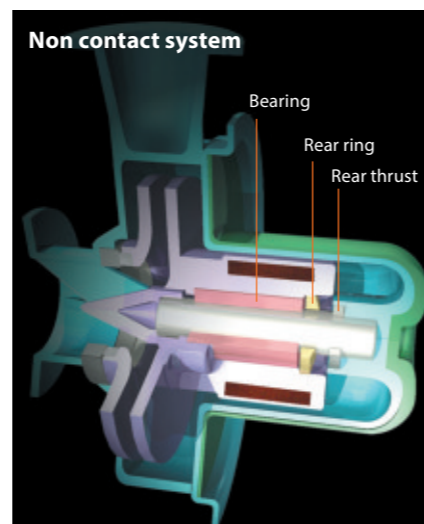

ETFE and PFA available in standard models

Carbon fibre reinforced CFRETFE and PFA linings can be supplied to meet many varying duties. PFA being a natural unfilled material generates fewer contaminants and makes it ideally suited for transfer of high purity chemicals.

Note: Long coupling type is only PFA version.

Highly durable structure

A ductile cast iron shell adds strength and durability to the outer peripheral surfaces of the fluoro-resin pump module. The rear casing which is placed under the highest stress is protected by a rear casing cover made from fibre reinforced plastic. This gives sufficient strength and eliminates the eddy current loss caused by the rotating magnetic field. Should it come into contact with the drive magnet unit, no spark would be generated and a high level of safety would be maintained.

Back pullout system

In order to facilitate inspection and maintenance, this series employs the back pullout system. This enables one to conduct inspections internally and replace parts without removing piping. The pump is designed to include safety measures that can prevent the liquid from leaking when the foot support (bracket) is pulled back.

Compliance with ISO standards (ISO2858/DIN EN22858)

The pump with a common base complies with ISO Standards in regard to piping connection.

Note 1: For compatibility in size with other series of our magnet pumps, please call us.
Note 2: ANSI and JIS standards are also available. For details, please call us.

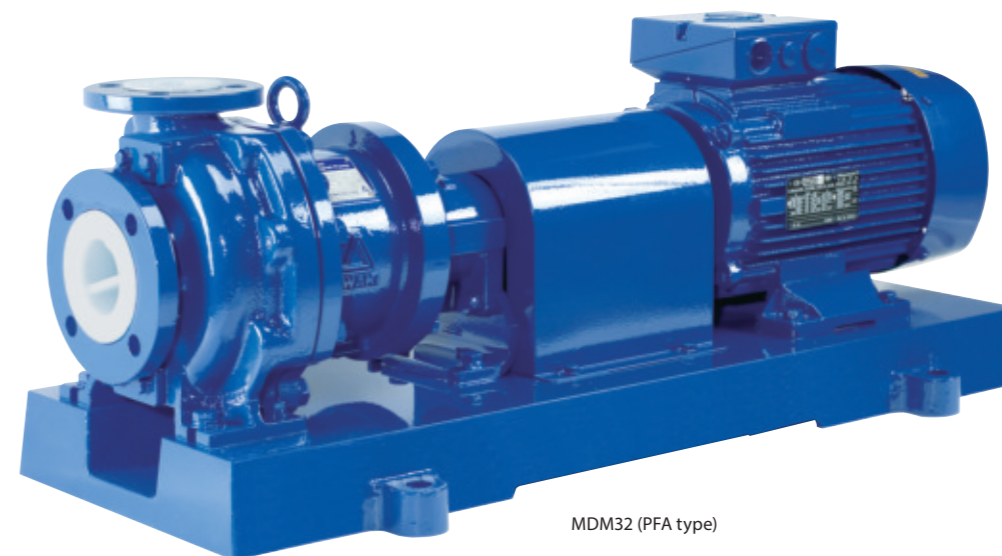
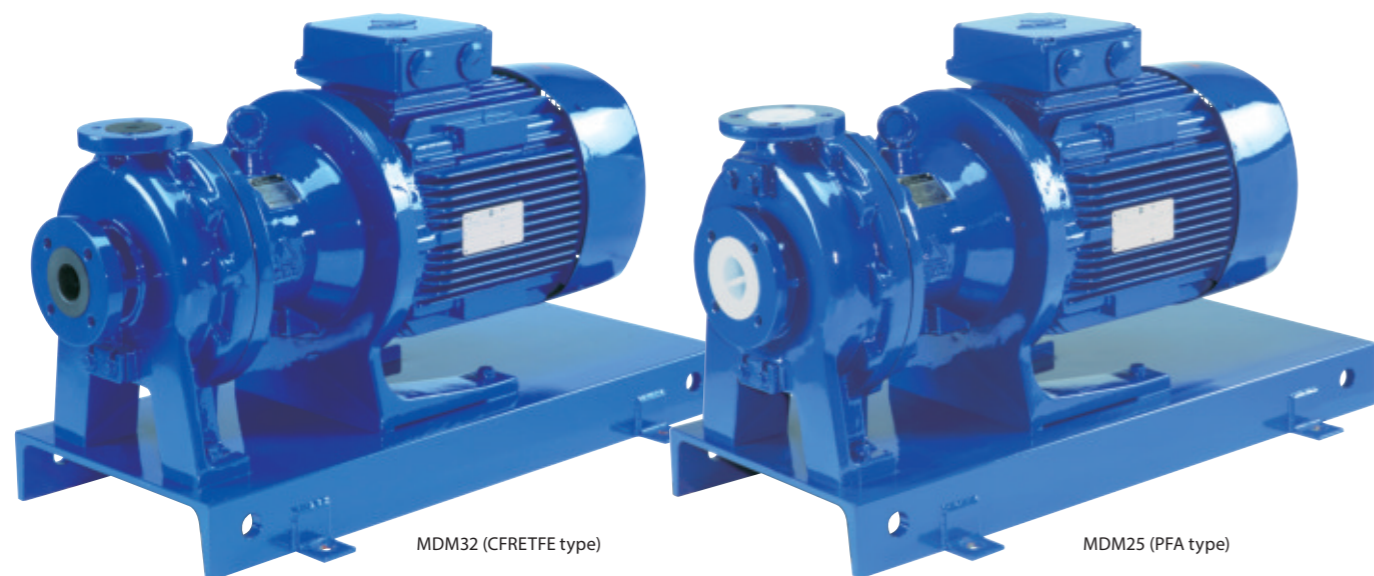
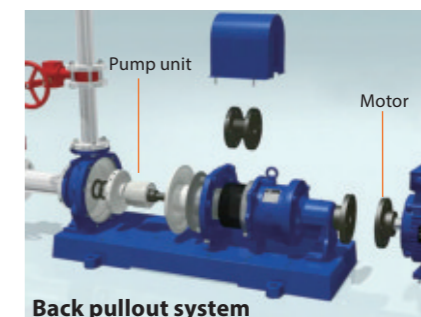

Construction

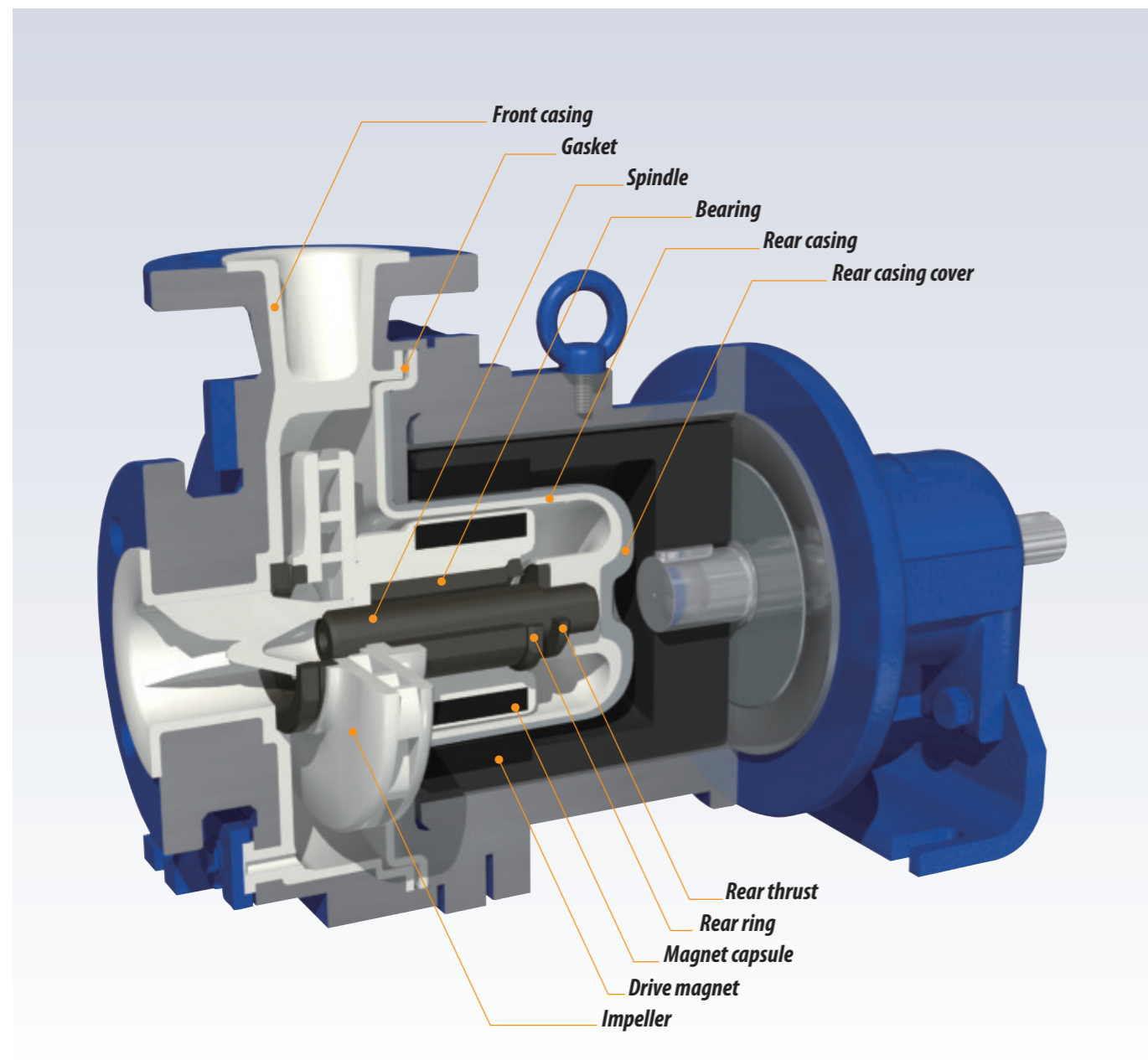

Materials	ECF	EKK	PKK/NKK
1 Front casing	CFRETFE	SiC	PFA
2 Rear casing (Note 1)			
3 Impeller			
4 Magnet capsule	High density carbon	SiC	SiC
5 Bearing			
6 Spindle			
7 Liner ring			
8 Mouth ring	PTFE (with Filler)	PTFE	
9 Rear ring	High purity alumina ceramic		
10 Rear thrust	PTFE (with filler)		
11 Gasket	PTFE		

Note 1: Rear casing support is used on MDM25-3 and MDM32-2 for applications over 80°C (PAT).

Front casing ETFE type

A moulding made of carbon fibre reinforced CFRETFE. It has both a high mechanical strength and excellent corrosion resistance. The outer peripheral surfaces are reinforced by a ductile cast iron outer casing in order to achieve excellent strength and durability.



CFRETFE type

Front casing PFA type

Natural PFA fluoro resin is adapted as wetted parts. This construction is free from contamination and ideal for transfer of clean liquids or with less particle generation.



PFA type

Impeller

Closed type impellers are designed to give high efficiency. To ensure positive fixing of impeller to magnet capsule a spline system together with a pin fixing is employed. This prevents the impeller from moving axially off the magnet capsule (PAT). MDM25 and 32 models now have impellers capable of reaching max. heads of 74 meters (50Hz) to widen the range of application.



CFRETFE type



PFA type

Rear casing
Rear casing cover

The fluoro resin rear casing is strengthened by the outer rear casing cover which is manufactured in fibre reinforced plastic capable of withstanding a pressure of 1 MPa. (Note: For long coupling type, maximum pressure is 1.6MPa.) This structure also eliminates any eddy current losses due to a rotating magnetic field. It also prevents sparks from being produced should the rear casing come into contact with the drive magnet unit.



PFA type with rear casing cover

A newly developed triple-layer casing (PAT.) is used for the high head models MDM25-3 and 32-2 when liquid temperature exceeds 80°C. This new design allows a rated 1.6MPa casing pressure overall temperature range. Since the front and rear casings are bolted together from the front casing side liquid does not leak out when the foot support (bracket) is pulled back.

Rear ring

To protect the pump against abnormal operation, such as cavitation or entrained air, where the magnet capsule could experience reverse axial thrust, a rear ring and rear thrust ring are used. The rear ring is designed to minimize heat generation compared to conventional designs. This prevents surrounding fluoro resin from melting. (PAT.)

Rear Thrust

The rear thrust withstands axial loads encountered from abnormal operation, it also minimizes heat generation.

Magnet capsule

High strength rare earth magnets are totally encapsulated with fluoro resin mouldings. Magnets are small and lightweight which increases the efficiency of the pump. Taking advantage of the high magnetic strength its new design of "Non contact system"(PAT.) was developed to protect pump from dry running. This enables us to offer pumps that will withstand dry running operation. (CF type only)



CFRETFE type



PFA type

Spindle

Both ends of the spindle are supported by the front casing and the rear casing (the fixed spindle type). There are two types of spindle; one is made of high purity alumina ceramic and the other made of SiC.



SiC type High purity alumina ceramic type

Bearing

Two standard bearing materials are available. SiC gives high resistance to abrasion. High density carbon withstands dry running operation. Bearings can be individually replaced.



SiC type High density carbon type

Gasket

A PTFE shrouded gasket is used to enhance sealing performance and corrosion resistance.

Specifications

2 pole motor type

50Hz

Model	Pump size Suction X Discharge	Impeller size	Capacity L/min	Head m	Motor kW
MDM25-1 (Impeller range 1)	40mm X 25mm	165	100	35.5	1.5 or 2.2
		160			
		150			
		140			
		130			
MDM25-2 (Impeller range 2)	40mm X 25mm	195	100	50.5	4.0, 5.5 or 7.5
		190			
		180			
		170			
		160			
MDM25-3 (Impeller range 3)	40mm X 25mm	225	100	74.0	5.5, 7.5, 11 or 15
		220			
		210			
		200			
		190			
MDM32-1 (Impeller range 1)	50mm X 32mm	165	208	35.0	4.0, 5.5 or 7.5
		160			
		150			
		140			
		130			
MDM32-2 (Impeller range 2)	50mm X 32mm	225	208	70.0	5.5, 7.5, 11 or 15
		220			
		210			
		200			
		190			
MDM40-1	65mm X 40mm	165	417	33.0	4.0, 5.5 or 7.5
		160			
		150			
		140			
		130			
MDM50-1	80mm X 50mm	165	833	38.5	5.5, 7.5, 11, 15
		160			
		150			
		140			
		130			

Note1: For long coupling type, head is 34.5m.
Note2: For long coupling type, head is 32.5m.

4 pole motor type

50Hz

Model	Pump size Suction X Discharge	Impeller size	Capacity L/min	Head m	Motor kW
MDM25-2 (Impeller range 2)	40 mm X 25 mm	200	50	12.0	1.5, 2.2, 4.0
MDM25-3 (Impeller range 3)	40 mm X 25 mm	225	50	15.0	1.5, 2.2, 4.0, 5.5
MDM32-1 (Impeller range 1)	50 mm X 32 mm	170	200	7.5	1.5, 2.2, 4.0
MDM32-2 (Impeller range 2)	50 mm X 32 mm	225	200	15.0	1.5, 2.2, 4.0, 5.5
MDM40-1	65 mm X 40 mm	170	300	7.0	1.5, 2.2, 4.0
MDM50-1	80 mm X 50 mm	170	500	8.0	1.5, 2.2, 4.0, 5.5

Common Specifications

• Temperature range of liquid handled	EKK/ECF: -20 to 105°C, PKK: -20 to 150°C, NKK: -20 to 120°C Note1	• Allowable maximum pressure	1.0 MPa (All long coupling type, MDM25-3 and MDM32-2 are 1.6MPa.)
• Allowable slurry (KK type only)	Please contact us.	• Standard color of paint	Ultra marine blue RAL5002

Note1: Please contact us when handling liquid temperature is outside range of 0°C to 120°C.
Should your requirement be beyond the specs. shown in this catalog, please contact your nearest Iwaki distributor.

Pump identification

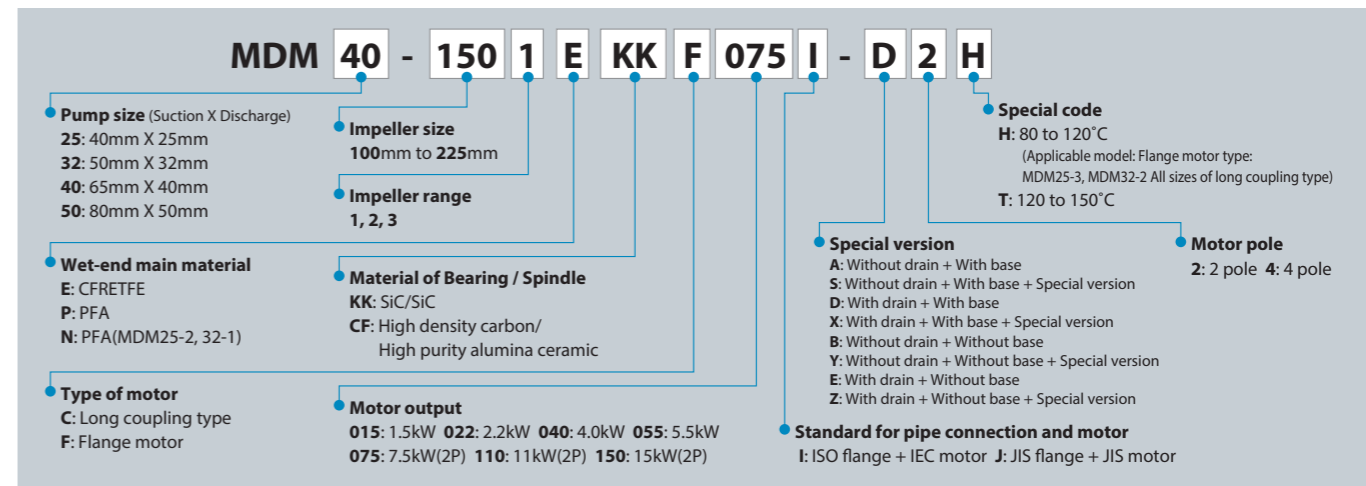

Note: Long coupling type is designed for 50 cycle area.

Performance curves

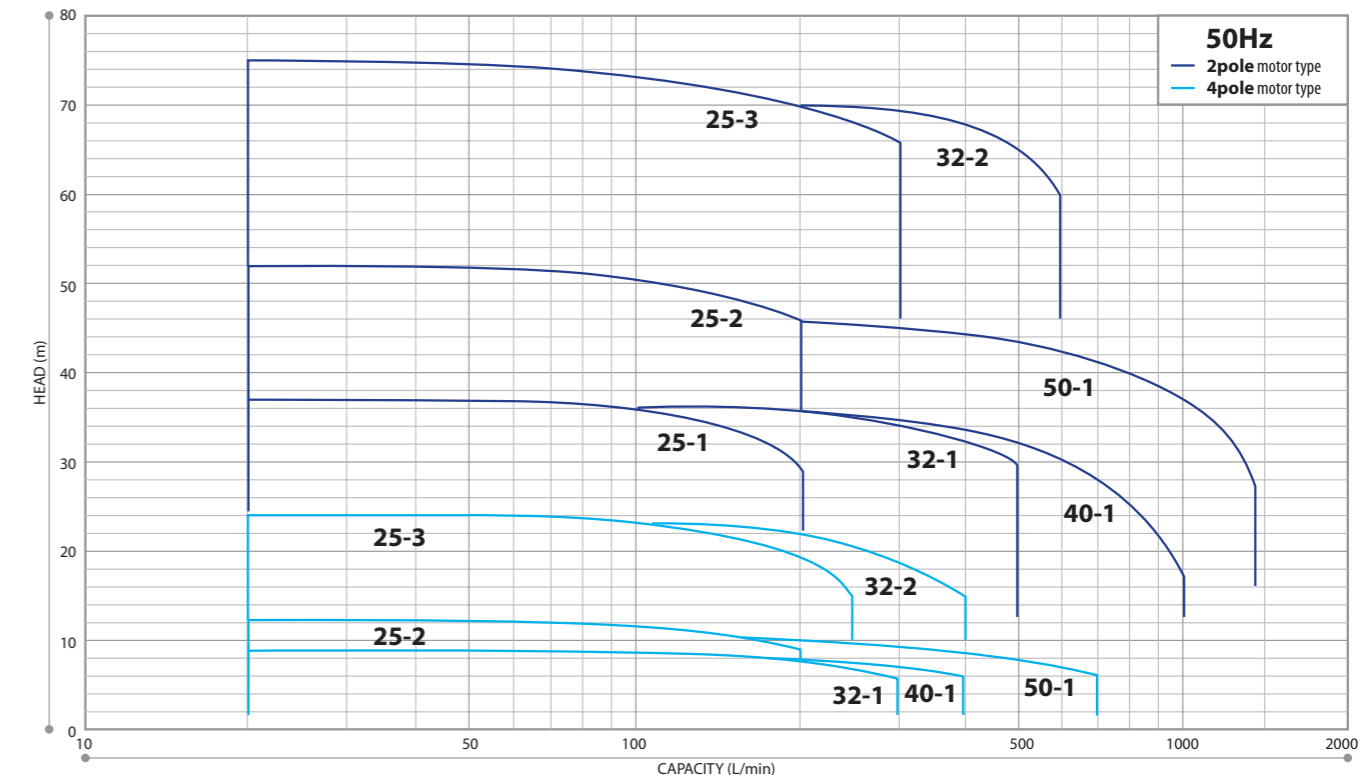

Optional accessories

Iwaki pump protector DRN series

Detects unusual pump operating conditions including dry-running and overload
The DRN model protects equipment (including pumps) from damage! Minimizes production downtime. Identifies possible causes of alarms so they can be investigated and addressed.



Multiple Input
Easy operation

Bar graph
Logging capability
Communication

Two analog, one digital, one temperature input and one current input
Equipped with EASY setup mode to remember the operation status and set the lower/upper limit values, as well as AUTO setup mode
Visible indication of current operating status
Data log feature for preventative maintenance scheduling
RS485 external communication capability

Specifications

Model	DRN-01	DRN-02
Amperometric range	0.5-30.00A	5.0-200.0A
Unit's source voltage	AC100-240V 50/60Hz 10VA	
Operating temperature	0-40°C	
Operating humidity	35-85%RH	

Dimensions

2 pole motor type

Flange motor type (with base type)

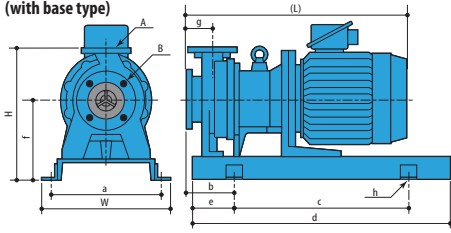

Flange motor type (without base type)

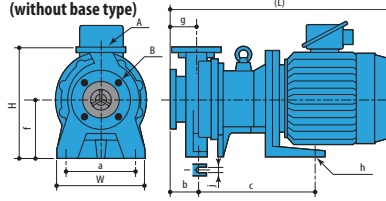

Long coupling type

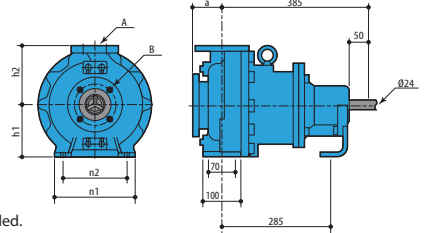

Note: The dimensions may differ with the type of motor installed.

Flange motor type with base

Model	Motor kW	(W)	(H)	(L)	a	b	c	d	e	f	g	h	A	B	Mass kg Less motor
MDM25-1	1.5	400	400	513	350	135	480	710	115	240	80	4xø19	25	40	63
	2.2			542											
	4.0			625											
MDM25-2	5.5	400	430	689	350	150	540	800	130	250	80	4xø19	25	40	89
	7.5			689											
	11			689											
MDM25-3	15	400	415	711	350	172	540	800	130	250	102	4xø19	25	40	100
	7.5			874											
	11			874											
MDM32-1	15	400	410	625	350	150	540	800	130	250	80	4xø19	32	50	84
	5.5			689											
	7.5			689											
MDM32-2	5.5	400	430	689	350	150	540	800	130	250	80	4xø19	32	50	105
	7.5			852											
	11			852											
MDM40-1	15	400	410	625	350	150	540	800	130	250	80	4xø19	40	65	85
	5.5			689											
	7.5			689											
MDM50-1	5.5	400	430	709	350	170	540	800	130	250	100	4xø19	50	80	96
	7.5			872											
	11			872											

Flange motor type without base

Model	Motor kW	(W)	(H)	(L)	a	b	c	f	g	h	j	A	B	Mass kg Less motor
MDM25-1	1.5	180	310	513	130	100	150	150	80	2xø15	15	25	40	37
	2.2			542										
	4.0			625										
MDM25-2	5.5	280	360	689	220	90	285	180	80	2xø14	14	25	40	62
	7.5			365										
	11			365										
MDM25-3	15	280	345	711	220	112	365	180	102	2xø14	14	25	40	70
	7.5			874										
	11			874										
MDM32-1	15	280	340	625	220	90	285	180	80	2xø14	14	32	50	57
	5.5			689										
	7.5			689										
MDM32-2	5.5	280	360	689	220	90	365	180	80	2xø14	14	32	50	75
	7.5			852										
	11			852										
MDM40-1	15	280	340	625	220	90	285	180	80	2xø14	14	40	65	58
	5.5			689										
	7.5			689										
MDM50-1	5.5	280	360	709	220	110	365	180	100	2xø14	14	50	80	69
	7.5			872										
	11			872										

Long coupling type without base, coupling, motor

Model	a	h1	h2	n1	n2	A	B	Mass kg Less motor
MDM32-1601	80	132	160	240	190	32	50	70
MDM32-2002		160	180					80
MDM40-1601		132	160					70
MDM50-1601	100	160	180	265	212	50	80	80



<https://www.iwaki.de>

IWAKI Europe GmbH, Siemensring 115, 47877 Willich, Germany
 TEL: +49 2154 9254 0 FAX: +49 2154 9254 48 E-Mail: sales@iwaki.de

Caution for safety use: Before use of pump, read instruction manual carefully to use the product correctly. Actual pumps may differ from the photos. Specifications and dimensions are subject to change without prior notice. For further details please contact us.

Legal attention related to export. Our products and/or parts of products fall in the category of goods contained in control list of international regime for export control. Please be reminded that export license could be required when products are exported due to export control regulations of countries. The posting and copying from this catalogue without permission is not accepted firmly.